

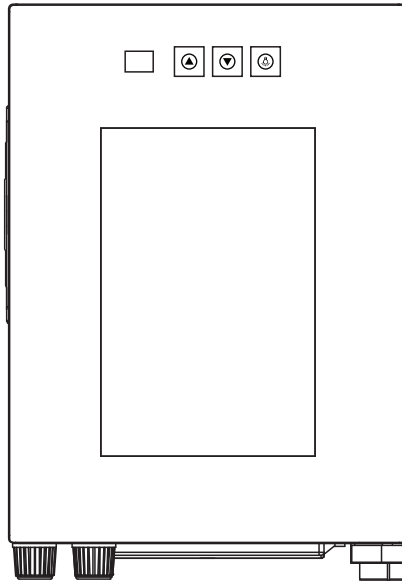

URBANLiving™

Freestanding Wine Cooler



User Guide

Please read this manual carefully before using the wine cooler and keep it for future reference. urbanlivingappliance.com MODEL # UBLWC6B

URBANLivingTM

Product Registration

Thank you for purchasing a Urban LivingTM product. The first step to protect your new product is to complete the product registration on our website: www.urbanlivingappliance.com The benefits of registering your product include the following:

1. Registering your product will allow us to contact you regarding a safety notification or product update.
2. Registering your product will allow for more efficient warranty service processing when warranty service is required.
3. Registering your product could act as your proof of purchase in the event of insurance loss.

Once again, thank you for purchasing a Urban LivingTM product.

TABLE OF CONTENTS

NAMES OF THE PARTS.....	2
IMPORTANT SAFETY INSTRUCTIONS.....	3
INSTALLATION INSTRUCTIONS	
BEFORE USING YOUR WINE COOLER.....	3
INSTALLING YOUR WINE COOLER	3
ELECTRICAL CONNECTION.....	4
OPERATING YOUR WINE COOLER	
TEMPERATURE CONTROL.....	5
CARE AND MAINTENANCE	
CLEANING YOUR WINE COOLER.....	6
VACATION TIME.....	6
MOVING YOUR WINE COOLER.....	6
ENERGY SAVING TIPS.....	6
TROUBLESHOOTING GUIDE.....	7-8
WINE COOLER WARRANTY.....	9

NAMES OF THE PARTS

MODEL NO. UBLWC6B

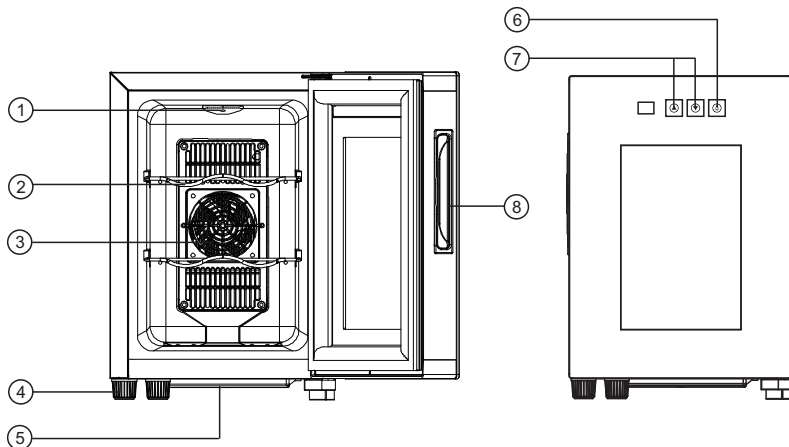

1. LIGHT

2. RACKS

3. FAN MASK

4. LEVELING LEGS

5. DRIP TRAY

6. LIGHT SWITCH

7. TEMPERATURE CONTROL PANEL

8. RECESSED HANDLE

IMPORTANT SAFETY INSTRUCTIONS

 WARNING	To reduce the risk of fire, electrical shock, or injury when using your wine cooler, follow these basic precautions:
<ul style="list-style-type: none">• Read all instructions before using the wine cooler.• Never clean wine cooler parts with flammable fluids. The fumes can create a fire hazard or explosion.• Do not store or use gasoline or any other flammable vapors and liquids in the vicinity of this or any other wine cooler. The fumes can create a fire hazard or an explosion.	
-Save these instructions-	

INSTALLATION INSTRUCTIONS

Before Using Your Wine cooler

- Remove the exterior and interior packing.
- Clean the interior surface with lukewarm water using a soft cloth. (Cleaning instruction on page 6)

Installing Your Wine cooler

- This appliance is designed to be free standing only, and should not be recessed or built-in.
- Allow 5 inches of space between the back and sides of the wine cooler, which allows the proper air ventilation. Adjust the legs to keep the wine cooler level.
- Locate the wine cooler away from direct sunlight and sources of heat (stove, heater, radiator, etc.). Direct sunlight may affect the acrylic coating and heat sources may increase electrical consumption. If the ambient temperature is higher than 80°F or lower than 55°F it will hinder the performance of this appliance. **This unit is not designed for use in a garage or any other outside installation.**
- Avoid locating the wine cooler in moist areas.
- Plug the wine cooler into dedicated, properly installed and grounded wall outlet. Do not under any circumstances cut or remove the third (ground) prong from the power cord. Any questions concerning power and/or grounding should be directed toward a certified electrician or an authorized service center. **This unit is not designed to be installed in an RV or used with an inverter.**
- After plugging the appliance into a wall outlet, allow the unit to cool down for 3 ~ 4 hours before placing wine bottles in the wine cooler.

Electrical Connection

⚡WARNING⚡

Improper use of the grounded plug can result in the risk of electrical shock. If the power cord is damaged, have it replaced by an authorized service center.

This wine cooler should be properly grounded for your safety. The power cord of this wine cooler is equipped with a three-prong plug which mates with standard three prong wall outlets to minimize the possibility of electrical shock.

Do not, under any circumstances, cut or remove the third ground prong from the power cord supplied.

This wine cooler requires a standard 110-120 Volt A.C. / 60Hz electrical outlet with three-prong ground.

This wine cooler is not designed to be used with an inverter.

The cord should be secured behind the wine cooler and not left exposed or dangling to prevent accidental injury.



Never unplug the wine cooler by pulling the power cord. Always grip the plug firmly and pull straight out from the receptacle.

Do not use an extension cord with this appliance. If the power cord is too short, have a qualified electrician or service technician install an outlet near the appliance. Use of an extension cord can negatively affect the performance of the unit.

If any problems with the appliance persist, please contact our Customer Service Dept. to consult with a representative at (877)856-0202 or visit our website to request warranty service at www.urbanlivingappliance.com

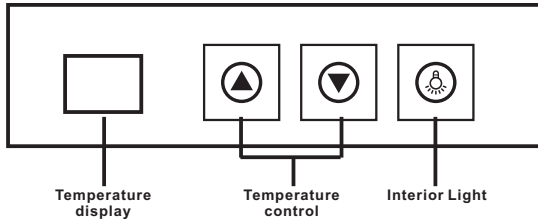
OPERATING YOUR WINE COOLER



- LIGHT SWITCH (): To manually illuminate/extinguish the interior light
- TEMPERATURE CONTROL PANEL (): Increase Temperature
- TEMPERATURE CONTROL PANEL (): Decrease Temperature

Temperature Control

The lead-time to achieve the pre-set temperature depends on the nature and quantity of the object placed inside the cavity.

The temperature range can be set as low as 46°F or as high as 66°F to suit your specific storage requirements. You can adjust the desired temperature by pressing the temperature control buttons.

The actual cabinet temperature in thermal electric units is dependent on the ambient room temperature. Thus, the unit may not reach the desired preset temperature. For example, when the ambient temperature is 77°F, the lowest cabinet temperature that the wine cooler can reach is approximately 46°F. When the ambient temperature is 82°F, the cabinet temperature can reach approximately 51°F.

In the event of a power failure or interruption, all modified settings will be lost.

CARE AND MAINTENANCE

Cleaning Your Wine cooler

- Upon installation of your new appliance, it is recommended that it be cleaned thoroughly.
- Unplug the unit from the wall outlet.
- Remove all contents.
- Wash the inside with a damp warm cloth soaked in lukewarm water and baking soda solution. The solution should be about 2 tablespoons of baking soda to a quart of water.
- Wash the racks with a mild detergent solution.
- Be sure to keep the door gasket (seal) clean to keep the unit running efficiently.
- The outside of the wine cooler should be cleaned with mild detergent and warm water.
- Dry the interior and exterior with a soft cloth.
- Dust or other accumulations blocking the vent may hinder the cooling efficiency of the wine cooler. Vacuum the vent if necessary.

Vacation Time

- Unplug the unit from the wall outlet.
- Remove all the contents.
- Clean the wine cooler.
- Short vacations: Leave the wine cooler operating during vacations of less than three weeks.
- Long vacations: If the appliance will not be used for several months, remove all content and unplug the power cord. Clean and dry the interior thoroughly. To prevent odor and mold growth, leave the door open slightly: blocking it open if necessary.

Moving Your Wine cooler

- Unplug the unit from the wall outlet.
- Remove all the contents.
- Securely tape down all loose items inside your wine cooler.
- Tape the doors shut.

Energy Saving Tips

- The wine cooler should be located in the coolest area of the room, away from heat producing appliances or heating ducts, and out of the direct sunlight.
- Ensure that the door is closed when the wine cooler is turned on.

TROUBLESHOOTING GUIDE

You can solve many common wine cooler problems easily, saving you the cost of a possible service call. Try the suggestions below to see if you can solve the problem before calling for service.

PROBLEM	POSSIBLE CAUSE
Wine cooler does not operate.	<p>Not plugged in.</p> <p>Make sure the wall socket is functional by testing another electrical appliance in the power socket.</p> <p>The circuit breaker tripped or a blown fuse.</p>
Temperature inside the wine cooler is too warm.	<p>Door is kept open too long or is opened too frequently. Warm air enters the wine cooler every time the door is opened. Open the door less often.</p> <p>The door is not closed completely.</p> <p>The door gasket does not seal properly.</p> <p>The wine cooler has recently been disconnected for a period of time.</p> <p>Temperature control is set too warm.</p> <p>Allow at least 24 hours for the internal temperature to adjust properly.</p> <p>*The interior temperature can be set between 46°F (8 °C) and 66°F (18°C) only at the room temperature of 77°F (25°C).</p> <p>To achieve accurate temperature control, the unit should not be used or operated in any of the following locations:</p> <ul style="list-style-type: none"> • in a sunny place. • in a room with poor air circulation such as a garage. • near another heat producing appliance (dishwasher, oven, refrigerator). • with an outlet shared with a refrigerator as it will drain power from the unit. • built-in a wall recess, niche or cabinet. • in a cabinet or closet. <p>And remember to have at least 5 inch (15 cm) of space on each side of unit.</p>
Temperature inside the wine cooler is too cold.	<p>Temperature control is set too cold. Turn the control to a warmer setting and allow several hours for the temperature to stabilize.</p>
Vibrations.	<p>Check to assure that the wine cooler is on a level surface.</p> <p>The wine cooler is touching the wall. Re-level the wine cooler and move it from the wall.</p> <p>If continued vibration occurs, unplug the unit from the wall outlet. Contact Customer Service Dept. for further assistance.</p>
Moisture forms on inside wine cooler walls.	<p>Door is slightly open.</p> <p>Door is kept open too long, or is opened too frequently. Open the door less often.</p> <p>The door is not sealed properly.</p>

The door will not close properly.	The wine cooler is not on a level surface. The gasket is dirty. The racks are out of position
Fan is always running.	This is simply a function of the cooling system. The lower the temperature setting, the more the fan will run. If the room is warmer than 77°F (25°C), it will run more.
There is a puddle of water under/around the wine cooler.	This wine cooler features a self-evaporation system. An external drip tray is therefore not required for accumulating condensation. If water forms under/around the wine cooler, the humidity level in the room is too high. Either try to lower the humidity level in the room (using, for example, a dehumidifier) or place the wine cooler in an another room.
General Statements	The unit does not use any CFC's. There is no compressor inside this unit. The cooling system is called a Peltier System.

URBANLivingTM

Limited Warranty

MC Appliance Corporation warrants each new Freestanding Wine Cooler to be free from defects in material and workmanship, and agrees to remedy any such defect or to furnish a new part(s), at the company's option, for any part(s) of the unit that has failed during the warranty period. Parts and labor expenses are covered on this unit for a period of one year from the date of purchase. A copy of the dated sales receipt/invoice is required to receive warranty service, replacement or refund.

This warranty covers appliances in use within the contiguous United States, Alaska, Hawaii and Puerto Rico. This warranty does not cover the following:

- Damages due to shipping damage or improper installation.
- Damages due to misuse or abuse.
- Punctures to the evaporator system due to improper defrosting of the unit.
- Content losses due to failure of the unit.
- Repairs performed by unauthorized service agents.
- Service calls that do not involve defects in material and workmanship such as instructions on proper use of the product or improper installation.
- Replacement or resetting of house fuses or circuit breakers.
- Failure of this product if used for other purposes than its intended purpose.
- Disposal costs for any failed unit not returned to our factory.
- Any delivery/installation costs incurred as the result of a unit that fails to perform as specified.
- Expenses for travel and transportation for product service if your appliance is located in a remote area where service by an authorized service technician is not available.
- The removal and reinstallation of your appliance if it is installed in an inaccessible location or is not installed in accordance with published installation instructions.
- Refunds for non repairable products are limited to the price paid for the unit per the sales receipt.
- This warranty is non transferable. This warranty applies only to the original purchaser and does not extend to any subsequent owner(s).

Limitations of Remedies and Exclusions:

Product repair in accordance with the terms herein, is your sole and exclusive remedy under this limited warranty. Any and all implied warranties including merchantability and fitness for a particular purpose are hereby limited to one year or the shortest period allowed by law. MC Appliance Corporation is not liable for incidental or consequential damages and no representative or person is authorized to assume for us any other liability in connection with the sale of this product. Under no circumstances is the consumer permitted to return this unit to the factory without the prior written consent of MC Appliance Corporation.

Some states prohibit the exclusion or limitation of incidental or consequential damages, or limitations on implied warranties. This warranty gives you specific legal rights, and you may also have other rights which vary from state to state.

Model	Parts	Labor	Type of Service
UBLWC6B	One Year	One Year	Carry In

For Service or Assistance please call (877)856-0202 or visit us on the web at www.urbanlivingappliance.com to request warranty service or order parts.



Urban Living™ is a trademark of CNA International, Inc. d/b/a MC Appliance Corporation.

www.urbanlivingappliance.com

Printed in China